

FLEX WIRE 4-12 AWG

UL AND CSA MARKING

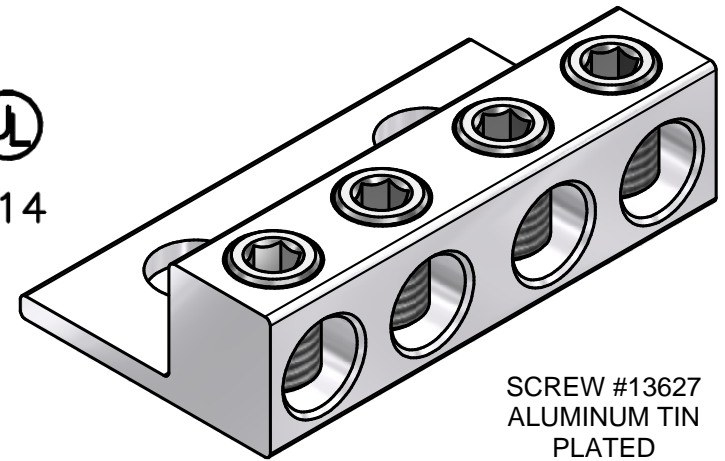

SCREW #13627
ALUMINUM TIN
PLATED

Cat. No. S2 Style No. ALL

■ Drill, Enlarge, or Modify Mounting Holes

- 1) Increase hole(s) dia. to 5/16 bolt (.323 drill dia.)
- 2) Move location of mounting hole(s)
- 3) If buying blank lug, put custom hole(s) in.

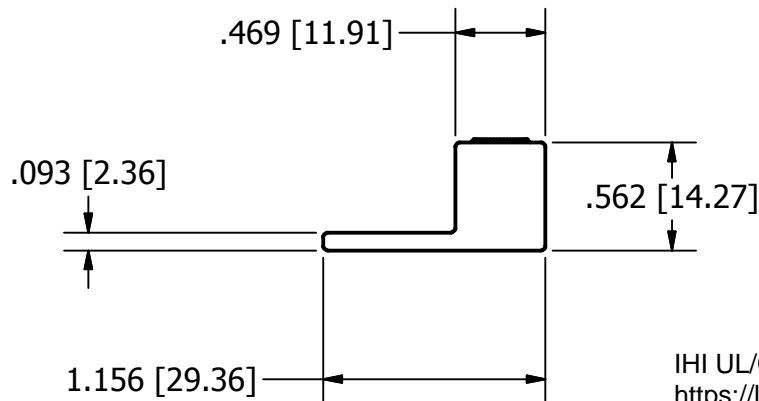

MOUNTING BOLTS: (2) EACH 5/16 OR M8

MAXIMUM CURRENT:

115A X 4 WIRES = 460A 75C

130A X 4 WIRES = 520A 90C

ZMVV LISTED FOR GROUNDING USE

SEE ALSO 600 VOLT STANDOFF KITS FOR POWER ISOLATION OR FLOATING GROUND

IHI UL/CSA Installation Guide to Drill or Enlarge Mounting Holes:

<https://lugsdirect.com/PDF%20Documents/IHI-MTG-HOLE-FIELD-MODS-UL&CSA-CERTIFICATIONS.pdf>

NOT FOR USE WHERE FAILURE CREATES A HAZARD TO HUMAN HEALTH OR SAFETY. ALL PRODUCTS ARE SUBJECT TO THIS FULL DISCLAIMER: <http://www.ihiconnectors.com/disclaimer.html>

FOR FURTHER INFORMATION ON THE PROPER USE OF THIS PRODUCT IN SPECIFIC APPLICATIONS SEE <http://www.ihiconnectors.com/GuideToFlexFlexibleFineStrandedWireCableMechanicalLugsFAQ.html>

<http://www.ihiconnectors.com/Technical-Data-Installation.htm>



Expanded wire range with use of ferrules.
TORK KRIMP®, self crimping of standard UL Listed ferrules protected by PATENT No. 10630005.
PATENT: www.ihiconnectors.com/patent.html
For full instructions: <https://lugsdirect.com/PDF Documents/IHI Agency Labels/S2-AGENCY-LABEL.pdf>

THIS DRAWING AND DESIGN ARE THE PROPERTY OF INTERNATIONAL HYDRAULICS, INC., CLEVELAND, OHIO, AND MAY NOT BE DUPLICATED, USED FOR THE BASIS OF DESIGN OR MANUFACTURE WITHOUT THE WRITTEN PERMISSION OF INTERNATIONAL HYDRAULICS, INC., CLEVELAND, OHIO.					INTERNATIONAL HYDRAULICS, INC.					
GENERAL TOLERANCES ±.015 (±0,39)					TITLE: 4 PORT POWER & GROUND LUG					
MATERIAL: 6061-T6					SIZE: A		DRAWN BY: cridley		DWG NO.: 4S2-13627 (SALES)	
FINISH: TIN PLATED					DATE: 12-19-2016		REV: 0		IHI CONNECTORS	
							2-14 X 4 WIRES			

Engineering Considerations for Aluminum Drive Electrical Screws

Background: Aluminum screws are used to provide higher current and heat range performance in aluminum body electrical connectors.

Typically, 90C temperature ratings, on compact terminals, are not able to pass UL486A-B testing without the use of aluminum screws.

Aluminum is softer than un-heat-treated steel so IHI typically uses high performance aircraft grade aluminum, 2000 series, particularly 2024-T4, which is a high end, strong alloy.

Examples: 10850 slotted screw ([pages 1-4](#)), for example has been made this way since 1987 and has an installed base of many millions Similarly, the sister part 13627 with a hex socket drive ([pages 5-6](#)), has been made since 1994 also with a huge installed base

Torque Requirements: Typically screw torque requirements for electrical connectors are quite modest, in the inch-pound range, not the foot-pound range, as would be normal for heat treated steel automotive and machinery screws.

That being the case slotted and hex socket drive recesses are designed to meet the modest torque requirements of these very special purpose screws.

Assembly: Fast assembly of screws is need to maintain low and highspeed drivers are utilized to insert screw on bodies. High tech proprietary toque limiting means are used to avoid any structural damage to aluminum slots and hex sockets.

Superficial Cosmetic driver scuffs: There is inevitably some outer corner scuffs and tin plating burnish marks, when the driver exits from the driving process. IHI driving technology and procedures minimize these marks and they are entirely cosmetic not functional defects.

1. Superficial Tin Plating Burnish Marks (satin finish polished to a bright shine)

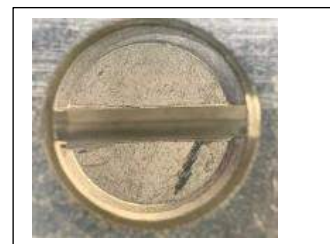
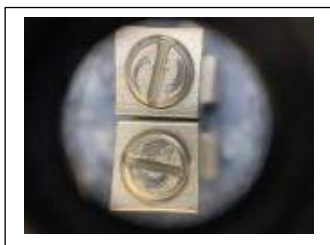

2. Superficial Screw Machine Tool witness Marks

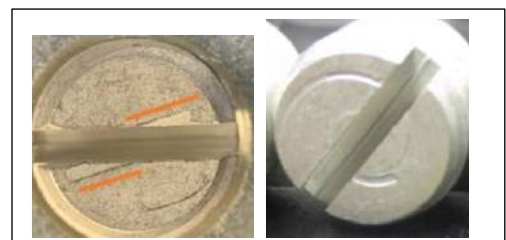
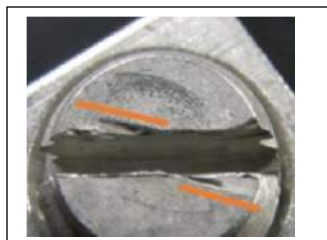
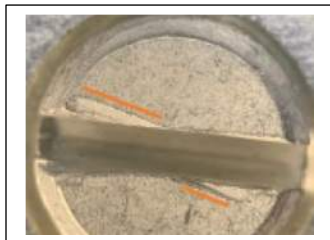

3. Superficial Driver Bit Bruise marks

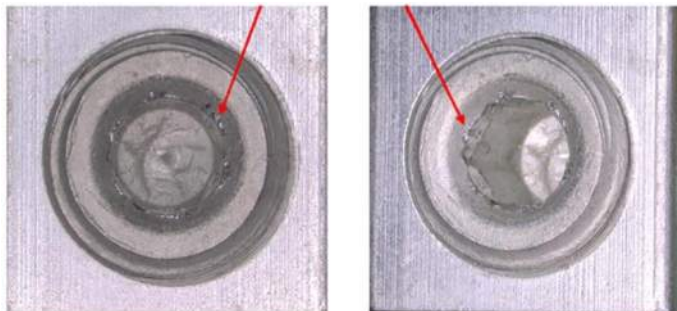
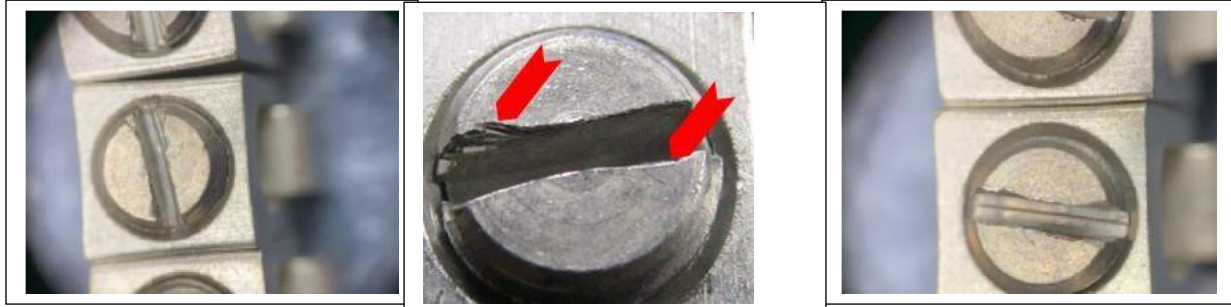

Superficial Cosmetics “No foul”.

IHI has to take the position that everything that can be done to avoid a percentage of slot artifacts coming from the screw making process and screw assembly process has been done, and the worst ones are not in any way functional defects. Certain superficial, cosmetic, tooling and assembly witness marks are part of the using aluminum for screws, and have to be accepted along with the advantages.

Justification – well beyond worst case test example

Testing of a slot deliberately damaged, multiple times worse than anything so far recorded as normal processing (see photos below deliberately damaged).

3. #2 AWG wire at 50 in-lbs torque AFTER creating a heavily bruised slot, orders of magnitude more than normal incidental cosmetic witness marks.

A. Before 50 in-lbs applied, a deliberate, very high level of upper slot damage inflicted. No screws are shipped at this level of real damage.

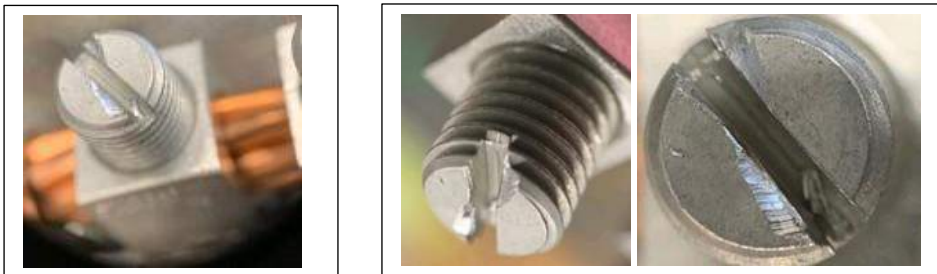

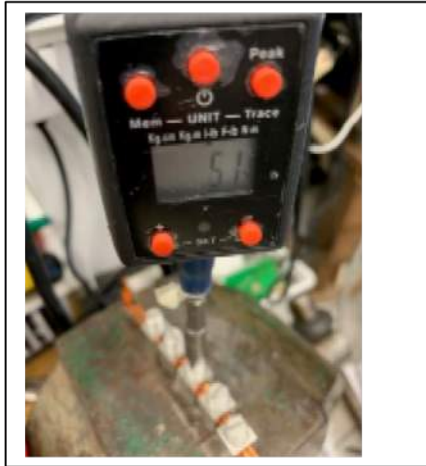

No problem reaching maximum working torque of 50 in-lbs on this same very pre-damaged slot.

Conclusions

1. On aluminum slotted drive screws, there will always be some evidence in the slot and on the top of the screw of assembly having occurred. The amount varies based on random factors not readily controlled.
2. Though evidence of assembly is visible it is not considered to be very noticeable except under 10X magnification.
3. Typically, the visible marks do not appear on the majority of screws in a lot but always appear in every lot in integer percentages.
4. The marks do not affect functionality.
5. The screw in use will appear more noticeably “reformed” in the slot than from assembly since X 25 times more torque used.
6. The “hour-glassing” of the slot shape is a fixed change that is self-limiting once the area under highest stress, plastically conforms to the surface area needed to support the torque
7. IHI does not accept that this aluminum screw slot deformability as a rejectable defect since it is a design consideration and has been accepted by the industry served for at least 30 years.
8. There is a learning curve to the proper driver bits for aluminum screws

Tips on the correct bit to avoid slot damage

Bit features and proper method:

1. Bit has parallel sides, not tapered to reduce cam-out
2. Bit has full thickness to fill the slot
3. Bit has Full width to capture the full length of the slot
4. Maintain bit a vertical bit direction, normal to the top of the screw
5. Exert sufficient downward pressure to avoid any cam-out of the bit. Bit to remain touching the bottom of the slot

Warning labels are recommended on aluminum screws:

“High Performance aluminum screws. Use the recommended driver bit and correct torque.

User damage to aluminum screws drive recess is not covered by warranty”

In case of accidental damage, replacement screws may be purchased here:

10850 slotted <https://lugsdirect.com/AluminumSetScrews/10850-slotted-set-screw-5-16-24x-1-2-oval-flat-point-aluminum-tin-plated.html>



Aluminum Hex Socket screws, for example part number 13627, are made from high performance (heat and current transfer) aircraft aluminum 2024-T4 and strong by aluminum standards bit still aluminum and are softer than steel so care is needed when selecting and using the hex driver.

Since the material is not very hard, the hex sockets are made deeper than regular alloy steel sockets to spread the torque stress over a longer, deeper engagement.

Modes of bit use failure including locking up are typically:

1. **ENGAGEMENT** Not engaging the bit to the full depth into the deep hex socket.
This can happen when either: (A) applying torque before the bit had dropped all the way into the recess depth or
(B) if the bit is a forged type which often have short hex lengths, too short for the hex socket, which is around 0.20 inch (5 mm) deep (13627). This is most likely to result in a partly stripped recess which may cause difficulty pulling out the bit too.

Many forged bits have rounded and underfilled hex points and do not meet the required over points diameter (ASTM B18.3).

A. BIT HEX LENGTH TOO SHORT, **DO NOT USE!**



Forged hex has rounded looking hex points, not fully formed sharp **-DO NO USE**

B. HIGH QUALITY MACHINED (MILLED) HEX FORM WITH EXTENDED HEX LENGTH



OK TO USE IF Length of hex is .20+ Inch (5+mm) long and .1390" (3.53mm) minimum across hex points (Milled Hex form) and if form is milled, not forged - see sharp hex points.

C. COLD ROLLED BITS (BLACK STEEL) **OK TO USE**



Hex form, continuously cold rolled hex stock, mounted in a socket holder are usually **the most conforming hex bit** type, if a good brand. Still check if meets the 0.1390" (3.53mm) per ASME B18.3 specs, and depth of hex is generally more than adequate.

- 2. **UNDERSIZE HEX POINTS DIAMETER** Any use of generic forged bits that are 1/8" hex bits, but commonly cheaply made, and have undersized point to point hex dimensions. Any hex bit under 0.1390" (3.53mm) (per ASME B18.3 specs) does not meet the hex key standard and should not be used. The hex point corners are the key to prevent cam locking (excessive rotation of the bit in the hex socket) **DO NOT USE**
- 3. **WRONG SIZE BIT** Any use of a 3mm (0.118 inch) hex bit in a 1/8" .125 inch hex will cause the .007" (0.18mm) undersized hex bit to damage the hex walls inside and create a locked up bit (camming = wedging action) so if that is the issue it is easily fixed by using a 1/8 inch (.125 inch) hex bit. Hex socket will be damaged by this. **DO NOT USE.** Similarly 1/8" bits that are undersize on hex points .1390" (3.53mm) dimension will start to exhibit this camming / wedging mode.



Warning labels are recommended on aluminum screws:

“High Performance aluminum screws. Use the recommended driver bit and correct torque.
 User damage to aluminum screws drive recess is not covered by warranty”
 In case of accidental damage, replacement screws may be purchased here:

13627 Hex socket <https://lugsdirect.com/AluminumSetScrews/13627-hex-socket-set-screw-5-16-24x-15-32-oval-point-aluminum-tin-plated.html>

Examples of bits that have been sampled and met the minimum sizes and length requirements.

There are other makers that make a good bit so we are not endorsing any particular brand.
 Check your bits! Especially the .1390" minimum over points. Quality varies, lot to lot, bit to bit.



L=.20"



0.1390" points, 0.125" flats,

L=.28"